

# ESCRS 2014

# \*Reducing the amount of Phaco energy by modulating Phaco curves - Clinical results with the Qubic Phaco mode



Tina Astecker

Klinikum Wels-Grieskirchen, Austria



# \*Financial Disclosure

Scientific advisor:

- Croma
- Hoya

Personal financial interest in products:

None



- Electric infusion pole and/or IPC System

- Fluid Path Adaption system\*

- Phaco 40 kHz +/- 2 kHz
- Phaco bimanual/ coaxial
- MICS/CoMICS
- Incision range for coaxial intervention:  
1,8 mm bis 3,2 mm

- Phaco Modes:

Burst time/ Burst counter

Constant/ Pulsed/ Qubic/ Width

- 12,1 inch touch screen

- Intuitive Graphical User Interface

- High flow cassette system

- Autoreflux

- Pneumatic Vitrectome up to  
1.500 cuts/ minute

- Dual-linear Footswitch

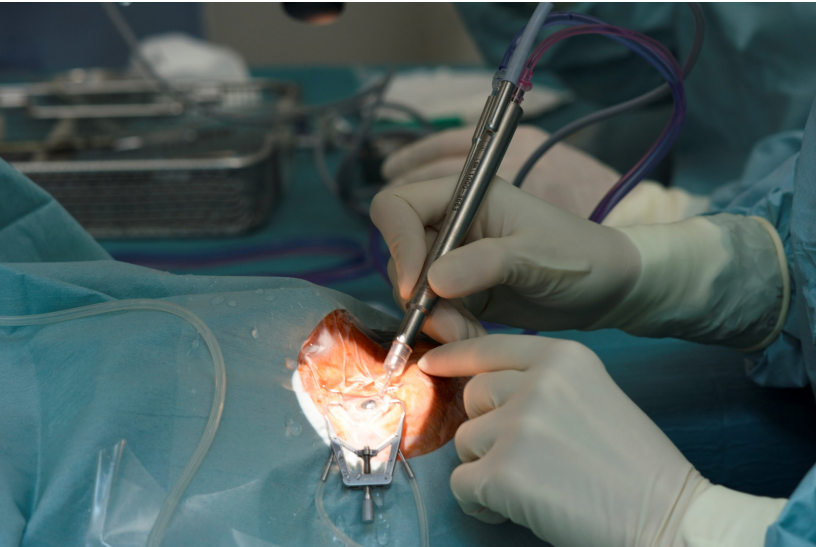

# \* Qube® Phaco system in the clinical routine



## User friendliness:

- \* One hand cassette system
- \* Assembly groups are pre-connected
- \* Facilitates quick changing times:  
convenient click-press-system

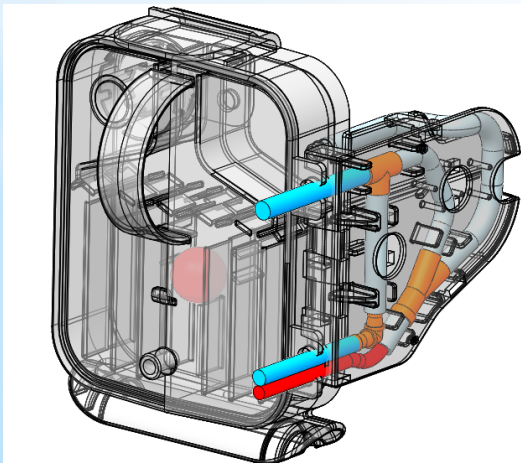

# \* Dual-linear Footswitch



- \* Dual-linear Footswitch  
with a central navigation pedal and  
9 freely programmable bumpers incl. Backflush-function

# \* Display



The display interface is organized into several functional areas:

- Top Bar:** Includes a status indicator (blue circle) with the text "e measured main pressure is below thresi", a battery level indicator showing 97% and -9, and a large empty rectangular button.
- Vertical Scale (Left):** A vertical scale labeled "cm" with markings from 30 to 130. It features a "+" button at the top and a "-" button near the bottom.
- Phaco Panel (Green Header):**
  - Current value: **18 %**
  - Limit 1: **20 %**
  - Sonic energy: **207 Joule**
- Aspiration Panel (Pink Header):**
  - Current value: **172 mmHg**
  - Limit 1: **200 mmHg**
  - Threshold: **20 mmHg**
- IPC Panel (Grey Header):**
  - Limit 1: **20 mmHg**
  - Limit 2: **30 mmHg**
- Diathermy Panel (Grey Header):**
  - Current value: **0 %**
  - Limit 1: **30 %**
- Vitreotomy Panel (Grey Header):**
  - Current value: **0 1/min**
  - Limit 1: **1000 1/min**
  - Button: **Test cutter**
- Right Side Panel (Grey Header):**
  - Section: **Phako 1**
  - Buttons: **I/A 1**, **Puls Phako**, **Polish**, **Vitreotomy**, **Diathermy**
- Bottom Bar:**
  - Buttons: **Permanent infusion** (water drop icon), **Prime** (syringe icon), **Call Standby** (person icon), **Options** (gear icon), **End intervention** (phone icon)





# \* IPC-Cassette-System: Infusion Pressure Control

\* Infusion Pressure Control for pressurising the infusion bottle. Fluid will be transported into the eye with a controlled air pressure.



- ✓ Independence from ceiling heights
- ✓ Constant fluid
- ✓ More safety (AC-stability)

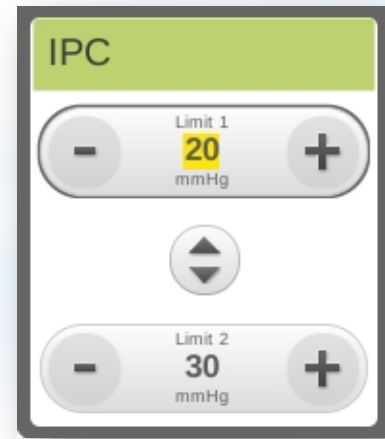

## NEW CATARACT SYSTEM









\* Video Wels OA Dr. Tina Astecker



Musik: Frametraxx

\* OP Video Qube®

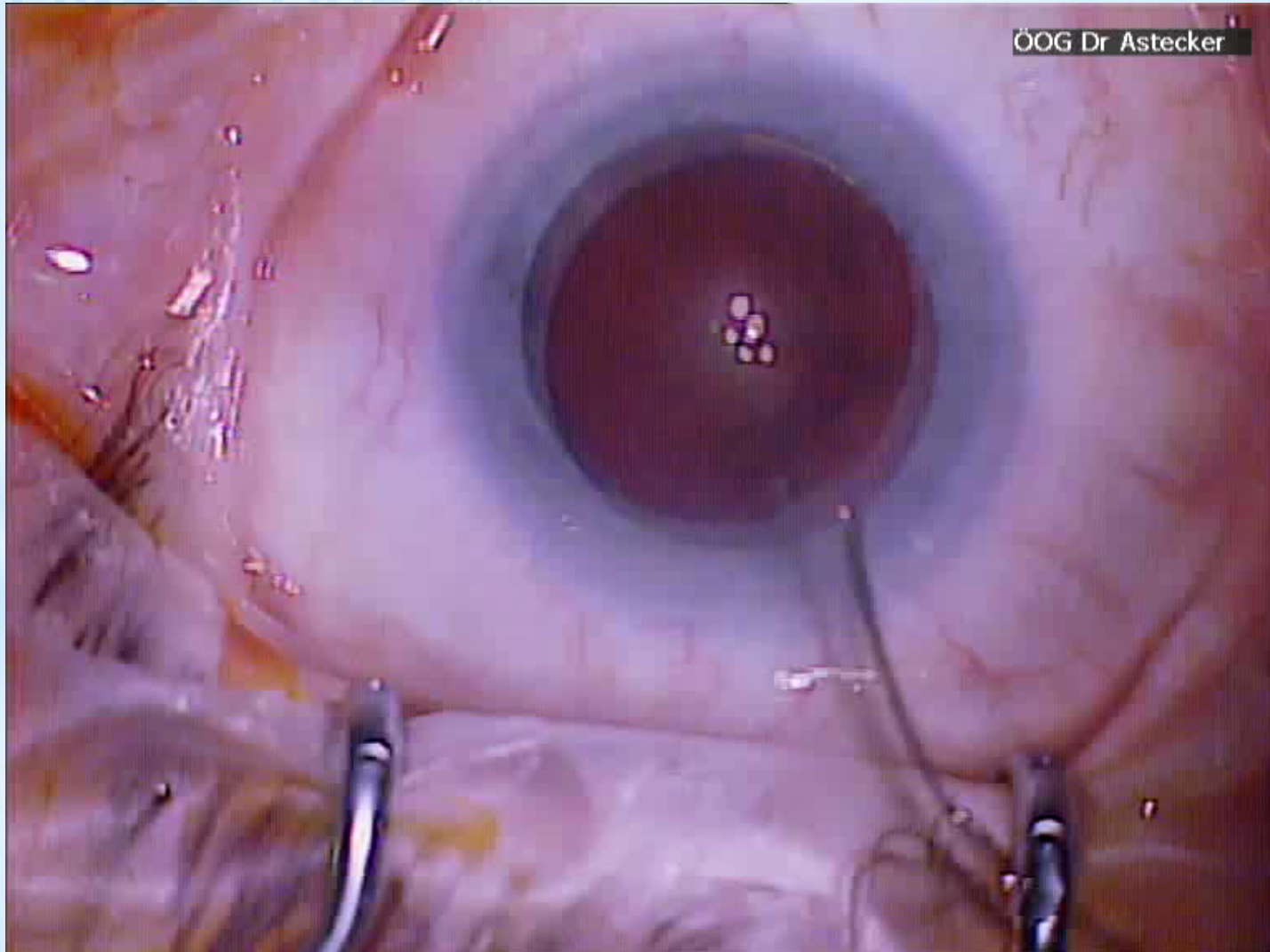

# \* Phaco modi : Linear / Qubic

## \* Pulsed Phaco linear

The Phaco power is divided into pulses. The Phaco limit is the max. amplitude of the pulses.

The output is set according to the Phaco Control Curve.

## \* Pulsed Phaco Qubic

The Phaco energy only slowly increases according to the footswitch movement.

But if there is a need for the highest amount of Phaco energy, the full effect is given.

## Pulsed Phaco

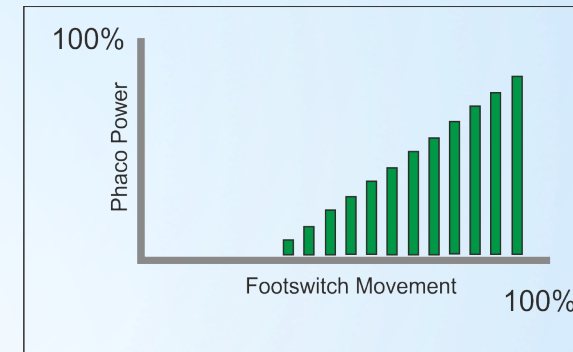

Linear

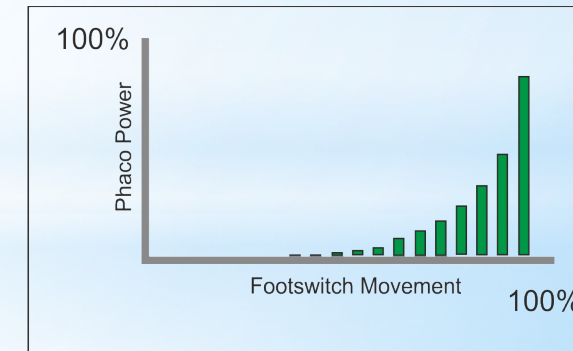

Qubic



# \* Clinical results:

## Settings OA Dr. Tina Astecker

### \* Phaco

Pulsed Qubic

40 % Limit

Pulse Rate

40 kHz (2-3)

IPC

50 mmHg

Aspiration

180/380 mmHg (Turbo)

Bottle height

70 cm

### \* I/A

IPC

55 mmHg

Base vacuum

120 mmHg

Max. Aspiration

350 mmHg

Bottle height

70 cm



The screenshot displays the control interface for a surgical microscope system. At the top, it shows the date and time (2014-05-05 11:11) and the duration of intervention (00:00:00). The user is identified as OA T. Astecker, performing a Soft/Medium Cataract IPC Qubic procedure.

The main control area is divided into several sections:

- Phaco (Phaco):**
  - Mode opératoire phaco:** Set to "Continu linéaire".
  - Limite phaco:** Set to 40%.
  - Seuil de vide phaco:** Set to 0 mmHg.
  - Courbe de contrôle phaco:** Set to "cubique".
- Aspiration (Aspiration):**
  - Limit: 180 mmHg.
  - Current value: 0 mmHg.
- CPI (CPI):**
  - Limit: 50 mmHg.
  - Current value: 0.0 % s.
- Diathermie (Diathermie):**
  - Limit: 50 %.
  - Current value: 0 %.
- Vitréotome (Vitréotome):**
  - Limit: 1000 1/min.
  - Current value: 0 1/min.
  - Button: "Test vitréotome".

On the right side, there are buttons for "Phaco", "Pulsed Phaco", "Aucun", "I/A", and "Vitrectomie antérieure". At the bottom, there are buttons for "Irrigation continue", "Test", "Options", and "Terminer l'intervention".

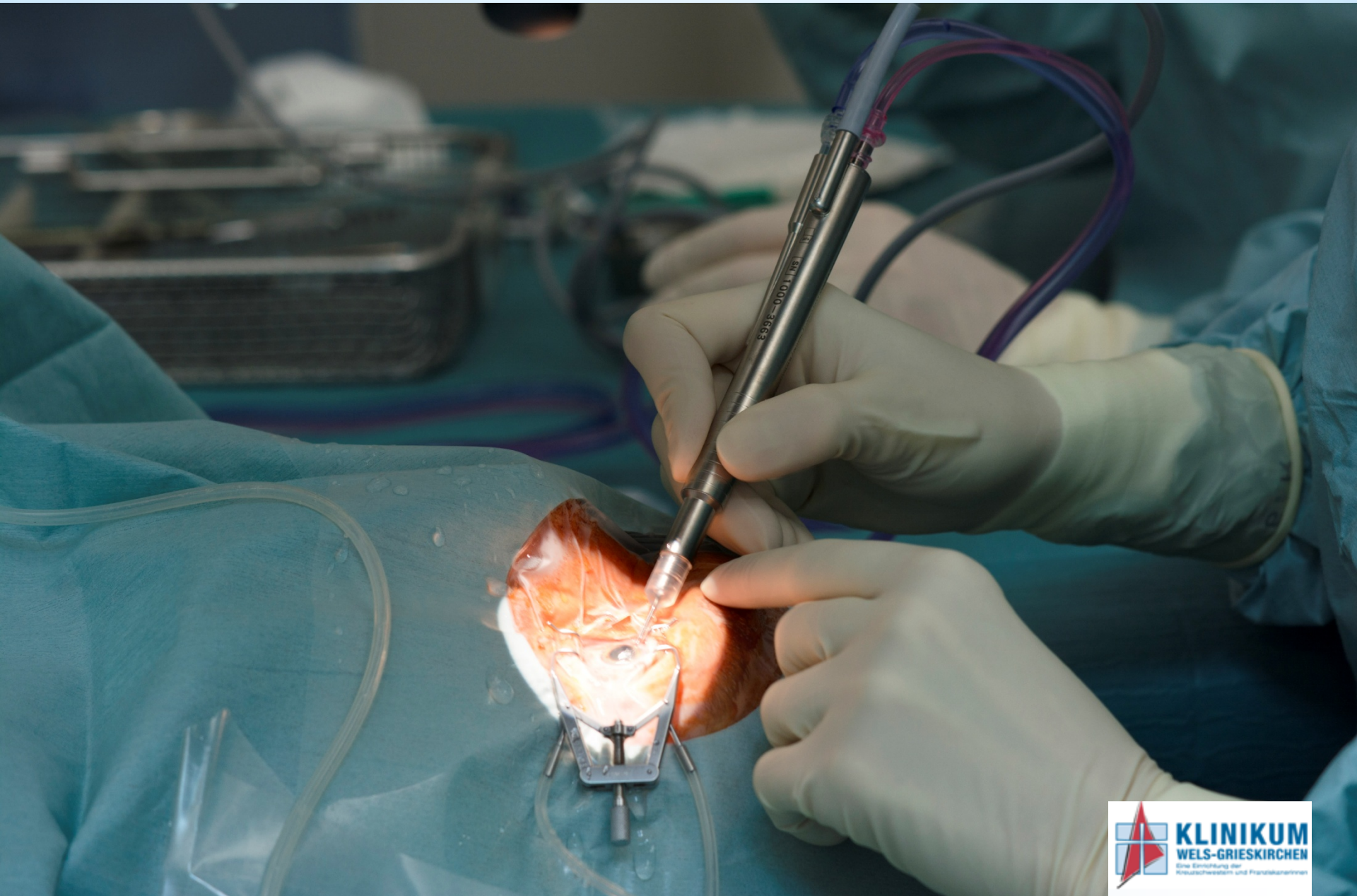

# \* Phaco on time linear mode: Average On Time: 34.4 sec.

Phaco on time

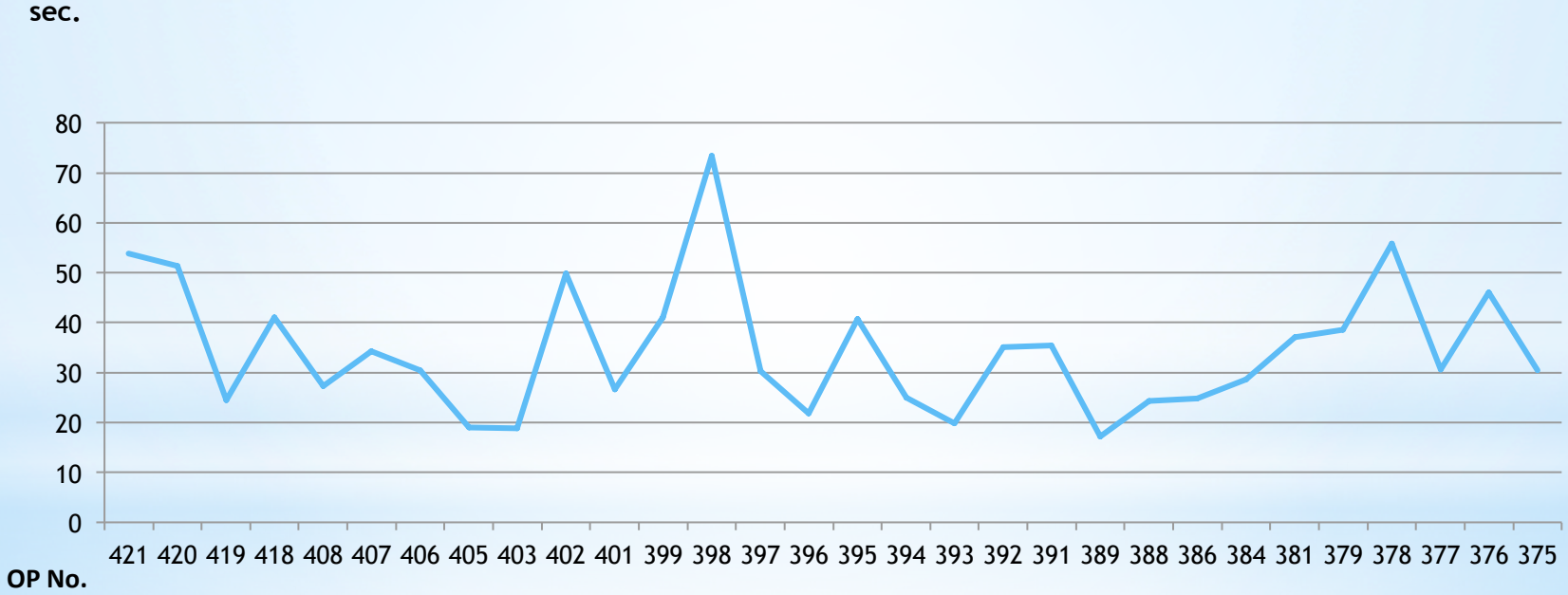

\* **Emitted energy linear mode:**  
**Av. effective On Time: 4.0 sec.**

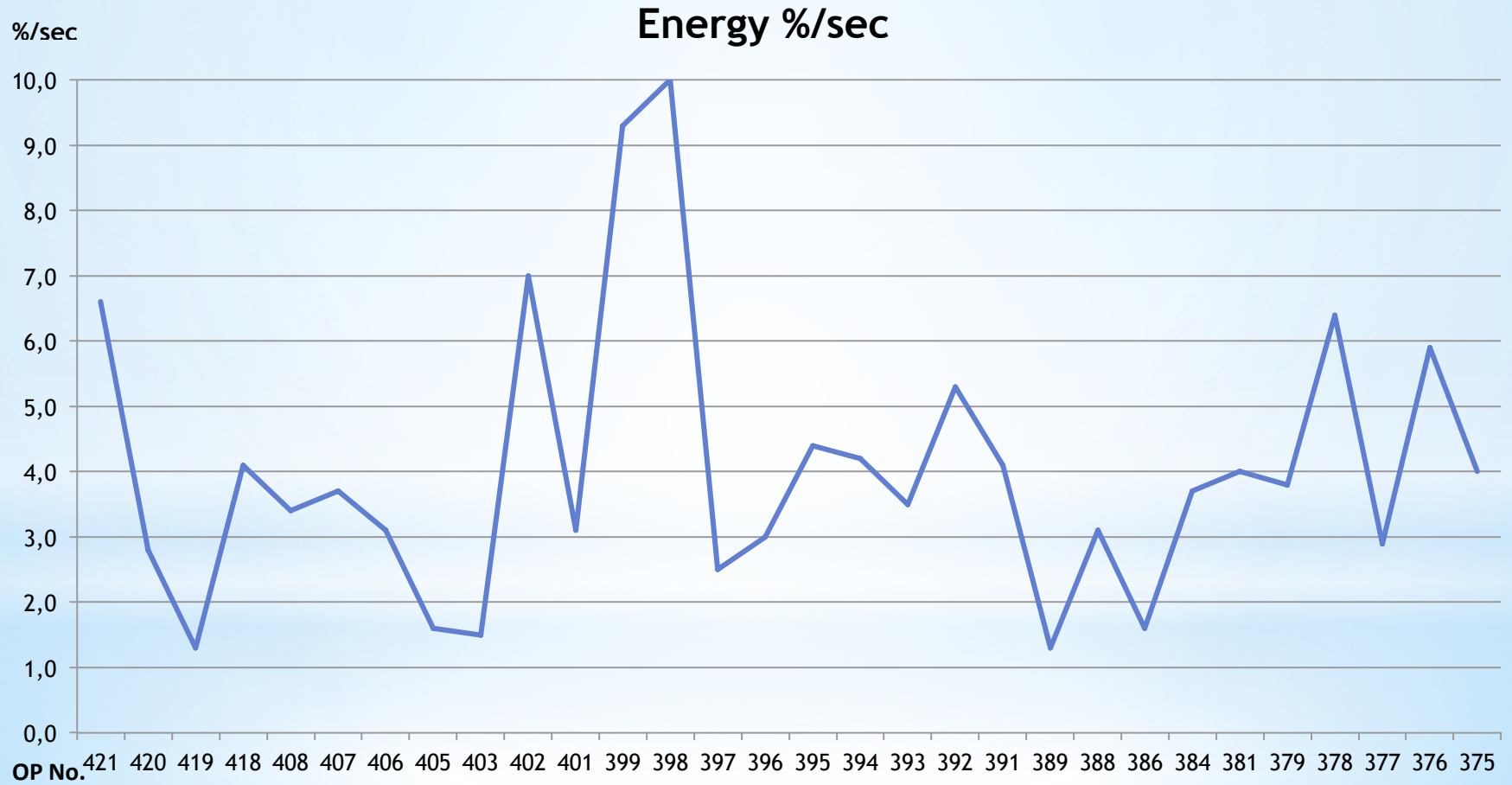

\* Phaco on time **Qubic mode:**  
**Average On Time: 37.9 sec.**

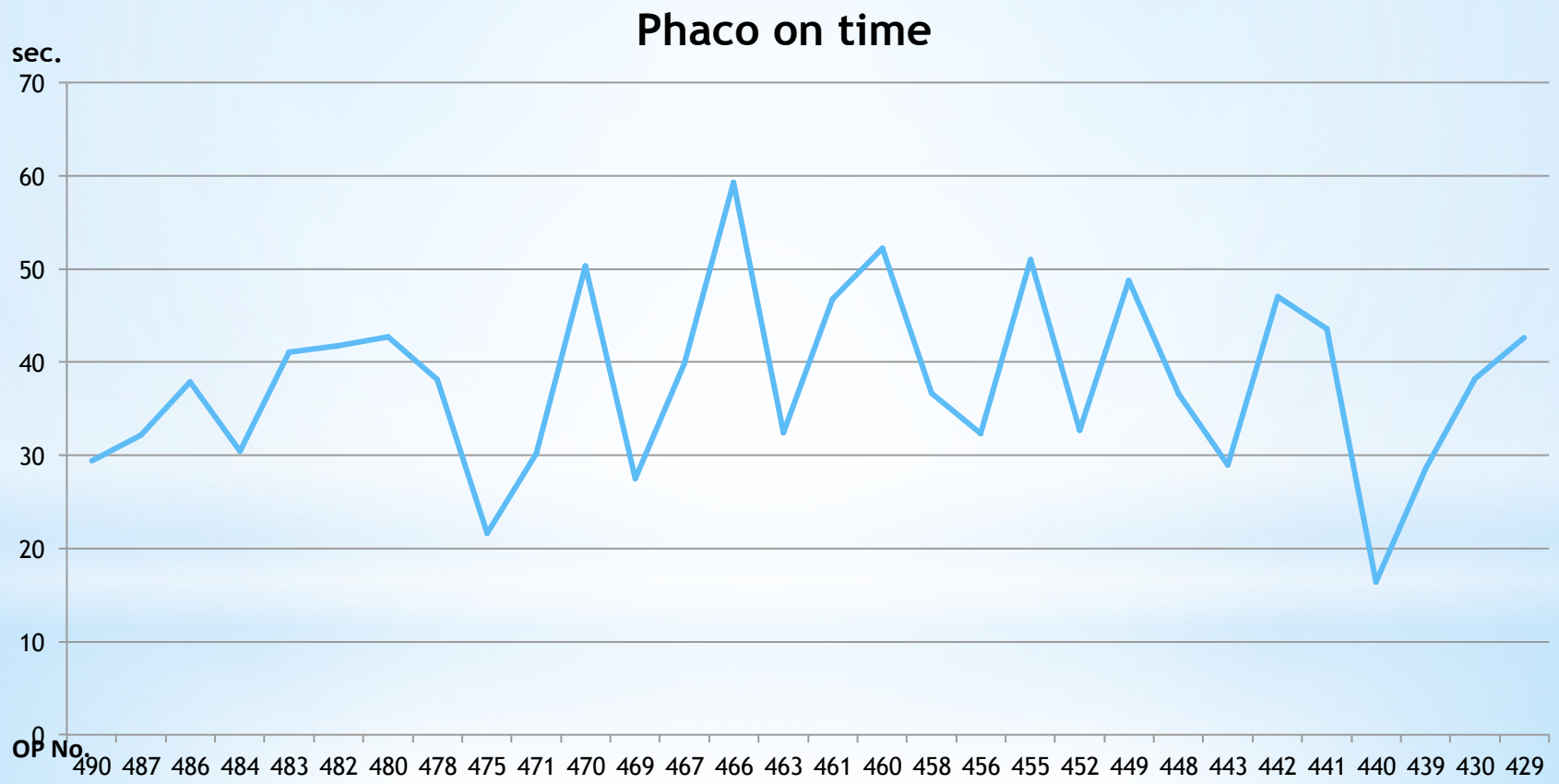

\* **Emitted energy Qubic mode:**  
**Av. Effective On Time: 2.1 sec.**

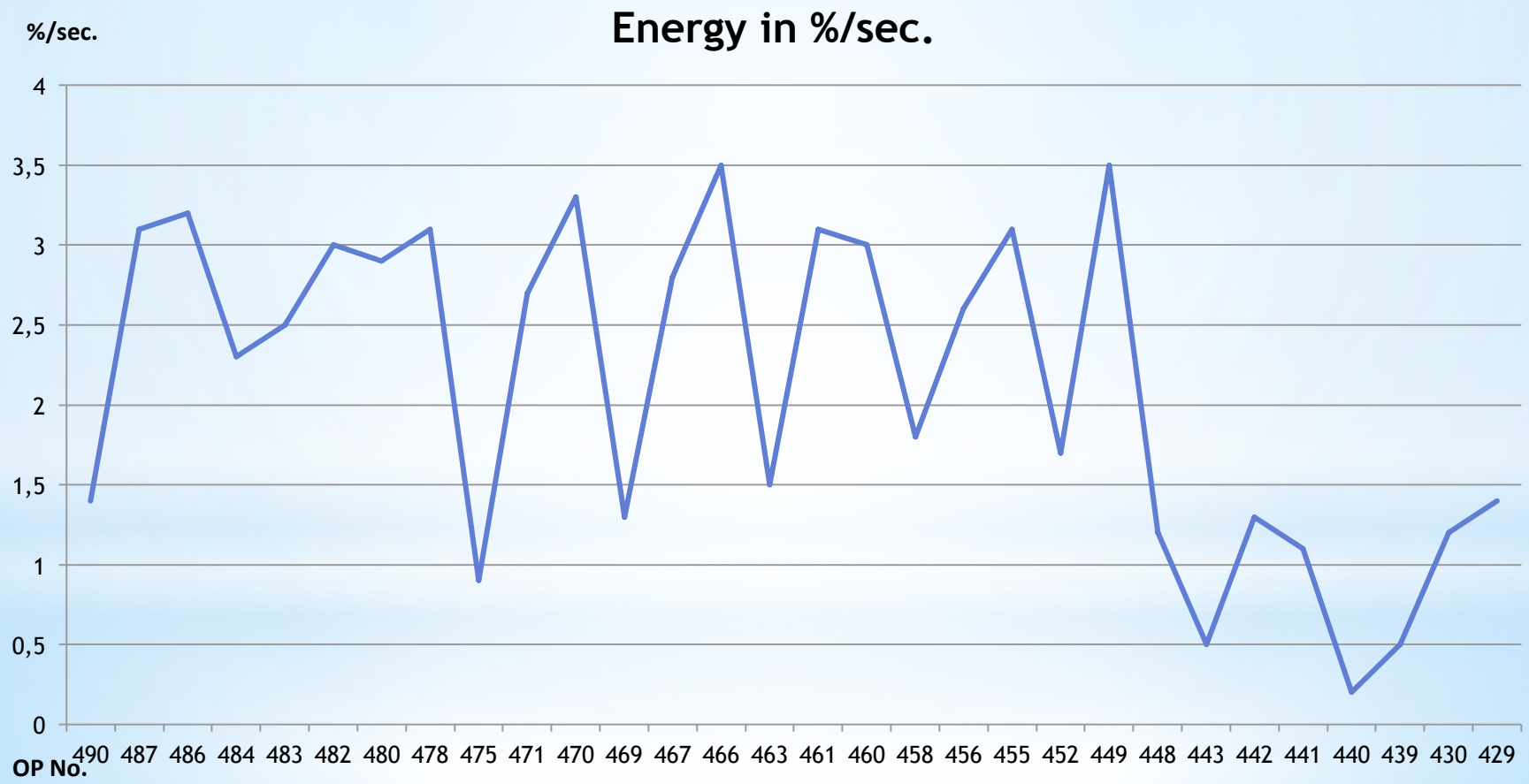

# \* Clinical results: Linear / Qubic Phaco mode

- |   |           |
|---|-----------|
| * Average Phaco on time Linear          | 34.4 sec. |
| * Average Phaco on time Qubic           | 37.9 sec. |
| * Average Effective On Time used Linear | 4.0 sec.  |
| * Average Effective On Time used Qubic  | 2.1 sec.  |
- \* While Av. Phaco on time only differs from 34.4 sec to 37.9 sec. between Linear and Qubic Phaco mode, we see a significant reduction in **Effective On Time** from average 4.0 to average 2.1 sec. per operation.



# \* Annex: Clinical data

| OP Number | Energy in %*s <b>Linear</b> | Phaco On time <b>Linear</b> | OP Number | Energy in %*s <b>Qubic</b> | Phaco On time <b>Qubic</b> |
|-----------|-----------------------------|-----------------------------|-----------|----------------------------|----------------------------|
| 421       | 6,6                         | 53,9                        | 490       | 1,4                        | 29,4                       |
| 420       | 2,8                         | 51,3                        | 487       | 3,1                        | 32,2                       |
| 419       | 1,3                         | 24,5                        | 486       | 3,2                        | 37,9                       |
| 418       | 4,1                         | 41                          | 484       | 2,3                        | 30,4                       |
| 408       | 3,4                         | 27,3                        | 483       | 2,5                        | 41,1                       |
| 407       | 3,7                         | 34,3                        | 482       | 3                          | 41,8                       |
| 406       | 3,1                         | 30,4                        | 480       | 2,9                        | 42,7                       |
| 405       | 1,6                         | 19                          | 478       | 3,1                        | 38,1                       |
| 403       | 1,5                         | 18,8                        | 475       | 0,9                        | 21,6                       |
| 402       | 7,0                         | 49,9                        | 471       | 2,7                        | 30,2                       |
| 401       | 3,1                         | 26,6                        | 470       | 3,3                        | 50,3                       |
| 399       | 9,3                         | 41,1                        | 469       | 1,3                        | 27,5                       |
| 398       | 10,0                        | 73,4                        | 467       | 2,8                        | 39,9                       |
| 397       | 2,5                         | 30,3                        | 466       | 3,5                        | 59,3                       |
| 396       | 3,0                         | 21,9                        | 463       | 1,5                        | 32,4                       |
| 395       | 4,4                         | 40,8                        | 461       | 3,1                        | 46,8                       |
| 394       | 4,2                         | 24,9                        | 460       | 3                          | 52,2                       |
| 393       | 3,5                         | 19,9                        | 458       | 1,8                        | 36,7                       |
| 392       | 5,3                         | 35,1                        | 456       | 2,6                        | 32,3                       |
| 391       | 4,1                         | 35,4                        | 455       | 3,1                        | 51                         |
| 389       | 1,3                         | 17,2                        | 452       | 1,7                        | 32,7                       |
| 388       | 3,1                         | 24,3                        | 449       | 3,5                        | 48,8                       |
| 386       | 1,6                         | 24,8                        | 448       | 1,2                        | 36,6                       |
| 384       | 3,7                         | 28,7                        | 443       | 0,5                        | 29                         |
| 381       | 4,0                         | 37,1                        | 442       | 1,3                        | 47                         |
| 379       | 3,8                         | 38,6                        | 441       | 1,1                        | 43,6                       |
| 378       | 6,4                         | 55,8                        | 440       | 0,2                        | 16,4                       |
| 377       | 2,9                         | 30,6                        | 439       | 0,5                        | 28,6                       |
| 376       | 5,9                         | 46                          | 430       | 1,2                        | 38,2                       |
| 375       | 4                           | 30,5                        | 429       | 1,4                        | 42,6                       |
| Average   | 4,0                         | 34,4                        |           | 2,1                        | 37,9                       |





# ESCRS 2014